

**Gas Engine Powered
Generating Sets
1370-1570 kWe 50 Hz
1100 kWe 60 Hz
QSV81G Series Engines**

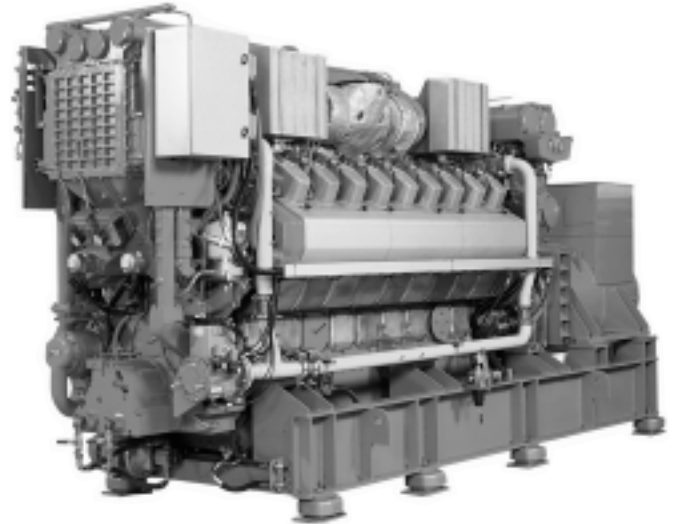

Standard Genset Features

Single Source Responsibility

Design, manufacture and testing of engine, alternator, control system and complete generating set are all produced by companies within the Cummins Group

International Integrity

Assurance and strength of a worldwide major corporation backing the product

Global Backing

24 hour spares and service availability in 72 countries

Single Source Warranty

Total product guaranteed by Cummins Power Generation

Packaged Units

Integrated unit with control panel, starting system and other accessories

Cummins Engine

- Heavy duty 4 cycle water cooled engine
- MCM700/SSM558 full authority electronic management
- Woodward PROACT actuator to drive throttle valve
- CENSE engine monitoring system

Ready Filled

Every set comes filled with lube oil

Alternator

- Brushless, self-exciting machine
- Close voltage regulation
- Rotor and exciter impregnated with oil and acid resisting resin
- 12 lead reconnectable
- Exceptional short circuit capability
- Low waveform distortion with non linear loads

Ratings

All kW Power ratings based on a 35°C ambient temperature reference. Refer to factory for deration for temperatures above 35°C and for operation in island mode.

Control System

- PCS PowerCommand Supervisor
- Totally reliable and proven system
- Microprocessor control
- Integrated voltage regulation
- Superior alternator and genset protection system
- HMI (touch screen) graphic interface
- PLC based auxiliary control



Quality Assurance
Registered Firm Certificate Number FM509 in accordance with:
BS EN ISO 9001
Quality Assurance Schedule 3420/1



Cummins Power Generation, Cummins Engines and Newage Alternators are all part of the same group

Ratings									
50 Hz					60 Hz				
Model	kWe	kVA*	rpm	Pressure bar (G)	Model	kWe	kVA*	rpm	Pressure bar (G)
1370 GQMA	1370	1712	1500	14	1100 GQMA	1100	1375	1200	14
1570 GQMB	1570	1962	1500	16	–	–	–	–	–

*@ 0.8pf

A Single Source for *all* Power System Solutions

Specifications

Generator Set Performance

Voltage Regulation

Maintains voltage output to within $\pm 1.0\%$.
At any power factor between 0.8 lagging and unity.
At any variations from No load to Full load.
At any variations from Cold to Hot.
At speed droop variations up to 4.5%.

Frequency Regulation

Isochronous under varying loads from no load to 100% full load.

Random Frequency Variation

Will not exceed $\pm 0.25\%$ of its mean value for constant loads – no load to full load.

Waveform

Total harmonic distortion open circuit voltage waveform in the order of 1.5%. Three-phase balanced load in the order of 5.0%.

Telephone Influence Factor (TIF)

TIF better than 50.
THF to BS4999 Part 40 better than 2%.

Alternator Temperature Rise

Class H insulation. Temperature rise up to 125°C permitted (low voltage only).

Radio Interference

In compliance with BS800 and VDE levels G and N.

Engine

Cummins QSV81G spark ignited lean burn gas combustion engines. 16-cylinder, V form.

Type

Water cooled, four cycle, turbo charged and aftercooled.

Construction

Four valves per cylinder, forged steel crankshaft and connecting rods, cast iron block, replaceable wet liners.

Fuel System

Safety shutdown solenoid valve, pressure regulator valve, manual shut-off valve, dust filter. Flexible fuel line.

Control

Fully integrated controls and monitoring including fuel system, ignition system and governing.
MCM700 provides engine protection, control and governing.
SSM558 caters for fuel and ignition protection and control.
CENSE provides detailed engine monitoring.

Filters

Dry element air filters with restriction indicator. Spin-on full flow paper element combination lube oil filters fitted. Spin-on corrosion resistor filter.

Starting

Pneumatic start system through single air starter motor.

Ignition

Individual coil on plug arrangement.

Cooling

Separate LT and HT cooling circuits. Coolant heater, water circulating pump and thermostat. Engine driven water pumps.

Alternator

Type

Brushless, two bearing, revolving field, 4-pole, drip proof, screen protected. Class H insulation (LV), Class F insulation (MV & HV). Enclosed to minimum IP22 as standard. IC 01 cooling system. Fully interconnected damper winding. AC exciter and rotating rectifier unit.

Epoxy coated stator winding. Rotor and exciter impregnated with tropical grade insulating oil and acid resisting polyester resin. Dynamically balanced rotor to BS5625 grade 2.5. Sealed for life bearings. Layer wound mechanically wedged rotor.

Exciter

Triple dipped in moisture, oil and acid resisting polyester varnish and coated with anti-tracking varnish. PMG self-exciting. Output windings with 2/3 pitch for improved harmonics and paralleling ability. Engine and alternator coupled via a flexible coupling.

Chassis

Fabricated and welded steel chassis
Spring anti-vibration mountings supplied loose

Finish

Etch undercoated and finished in high gloss durable green

General

Complete set of operating and instruction manuals

Testing

Fully tested against a resistive load. Copy of test certificate provided.

Compliance Standards

To BS4999/5000 pt 99,
VDE 0530, UTE5100,
NEMA MG1-22, CEMA,
IEC 34, CSA A22.2,
AS1359, BSS5514,
ISO 3046 and ISO 8528

Control System GCP System Configuration

Fully Integrated System

- PC based HMI (touchscreen)
- PowerCommand Supervisor™
- PLC based auxiliary control
- A.C. auxiliaries enclosure
- D.C. engine interface enclosure

Stand-alone or Parallel Operation

- Single or multi-set isolated bus operation
- Single set base load utility paralleling
- Isolated bus paralleling control
- Base load utility paralleling control

H.M.I. (Touchscreen)

- Micro-processor based graphic interface (touchscreen)
- Layered menus for ease of operation

System Screen

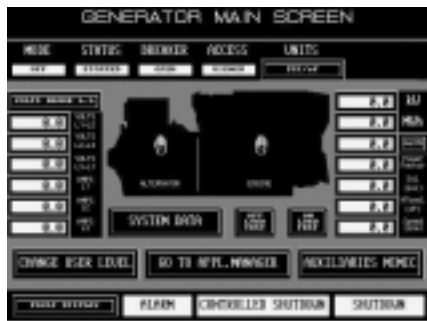

- Plant status
- Electrical data
- Mechanical data
- Test
- Access to other screens

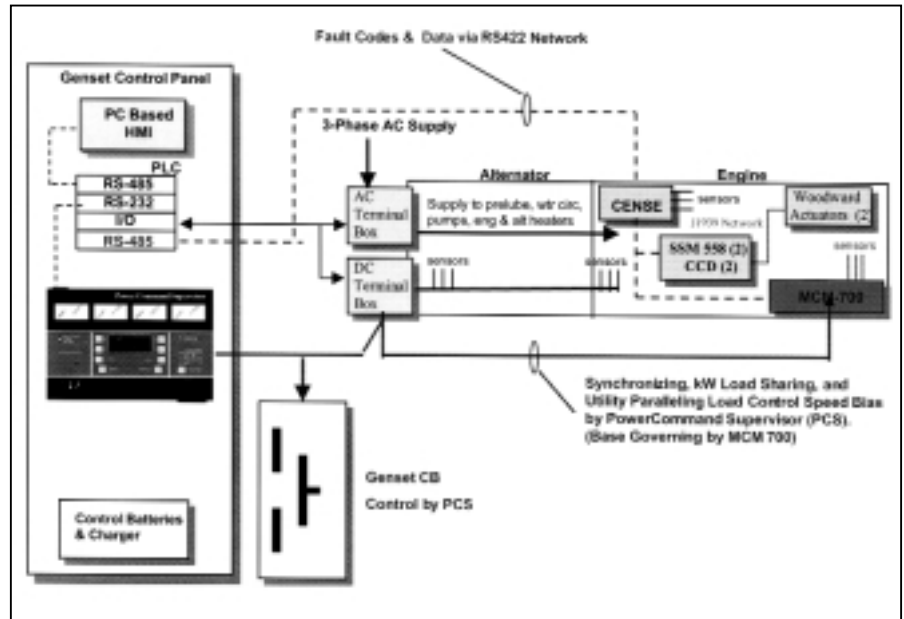

Plant Screens

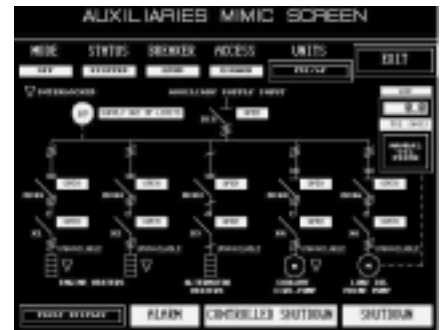
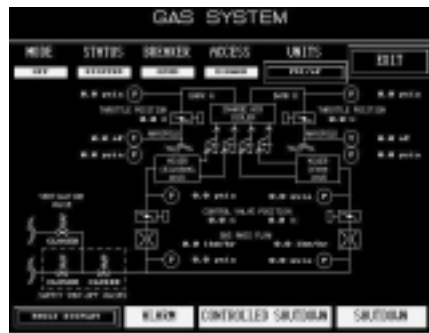

Other Screens

- Systems Data (restricted access)
- Engineers Data (restricted access) – all MCM700 data
- Fault Management Screens – reports and logs faults – summary/historical data – real time recording of faults



Control System

PowerCommand® Supervisor Control with AmpSentry™ Protection

- Integrated automatic voltage regulator. Speed/load bias to MCM700
- AmpSentry Protection guards the electrical integrity of the alternator and power system from the effects of overcurrent, over/under voltage, under frequency and overload conditions
- Control components designed to withstand the vibration levels typical in generator sets

Standard Control Description

- Analog % of current meter (amps)
- Analog AC frequency meter
- Analog AC voltage meter
- Analog % of load meter (kW)
- Digital display panel
- Emergency stop switch
- Menu switch
- Panel backlighting
- Reset switch
- Run-Off-Auto switch
- Sealed front panel, gasketed door
- Self diagnostics
- Separate customer interconnection box
- Voltmeter/Ammeter phase selector switch

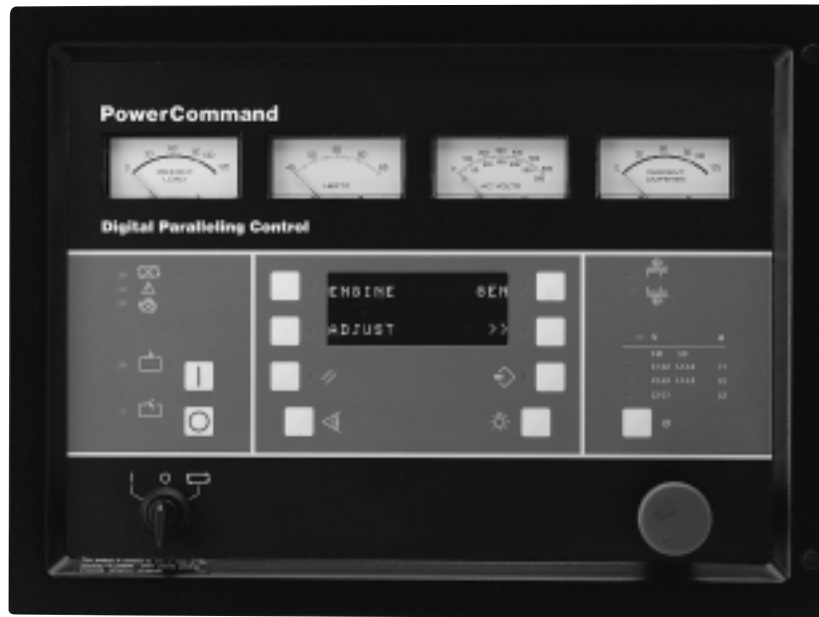

PCS PowerCommand Supervisor standard configuration

Standard Performance Data

AC Alternator Data

- Current by Phase
- Kilowatts
- Kilowatt Hours
- Power Factor
- Voltage Line to Line
- Voltage Line to Neutral

Engine Data

- Battery Voltage (for electric start option)
- Coolant Temperature
- Engine Running Hours
- Engine Starts counter
- Oil Pressure
- RPM
- Oil Temperature

EMC Compliance

The PCS control system meets EMC Shield Regulations.

Standard Protection Functions

Warnings

- Analogue Sender Failure
- High DC Voltage
- EEPROM Failure
- Low DC Voltage
- Over Current

- Phase Rotation
- CB Fail to Close
- Live Bus
- Up to Four Customer Fault Inputs
- Weak Battery (electric start option)

Shutdowns

- EEPROM Failure
- Loss of Excitation
- Reverse Power
- Fail to Synchronise
- Magnetic Pickup Failure
- Underfrequency
- Overcurrent
- Overspeed
- Short Circuit
- Low AC Voltage
- High/Low AC Voltage

Voltage Regulation

±0.5% with PowerCommand fitted.

PLC Auxiliary Control

- Communication handling procedures
- Protocol interfaces
- Control of plant auxiliaries

AC Auxiliaries Enclosure

- Incoming auxiliary a.c. supply for set
- Control/monitors/protects generator set a.c. systems not located in the GCP

DC Engine Interface Enclosure

- Interfaces between GCP and genset

Other Items

- Battery charger and batteries for GCP



Technical Data

	Units	50 Hz	50 Hz	60 Hz
Generator Set Data				
Model		1370 GQMA	1570 GQMB	1100 GQMA
Generator electrical output	kWe	1370	1570	1100
Alternator voltage regulation		+/-1%	+/-1%	+/-1%
Alternator protection class		IP22	IP22	IP22
Alternator insulation/temperature rise		H/H	H/H	H/H
Starting air bottle recommended pressure	bar (G)	30-40	30-40	30-40
Electric starter voltage	V	24	24	24
Minimum battery capacity @ 20°C	Ah	720	720	720
Engine Data				
Engine Model		QSV81-G	QSV81-G	QSV81-G
Bore	mm	180	180	180
Stroke	mm	200	200	200
Capacity	litres	81.44	81.44	81.44
Configuration		16 V	16 V	16 V
Aspiration		TCA	TCA	TCA
Engine speed	rpm	1500	1500	1200
BMEP	bar (G)	14	16	14
Effective mechanical output with engine driven pumps	kW	1425	1629	1140

COP rating in accordance with ISO 8528 and BS5514 at a maximum aspiration air temperature of 35°C, a maximum altitude of 1000 metres above sea level and with the generator sets operating in parallel with the utility. No overload available.

For detailed technical data on the various engine versions available refer to the specific data sheet.



Optional Items

Generator Set Options

Engine

- Heavy duty air cleaner
- Sump drain pump
- Oil and water drain taps
- Automatic sump oil make-up valve
- Flexible engine connections
- CE Compliance (guarding)
- Exhaust temperature monitoring
- Tool kit
- 2/3rds TA Luft
- 24V electric starting
- Dual pneumatic/electric starting
- Air starting module

Alternator

- 380-440 V, 3.3 kV, 6.3-6.6 kV, 11 kV-50 Hz
- 380-690V, 4-16 kV, 13.8 kV-60 Hz
- Left or right hand cable access
- 105°C rise alternator (LV machines only, standard on MV and HV)

Fuel System

- Gas flow meter
- Pressure regulating valves
- Flexible connecting pipe

Cooling

- 30°C ambient radiator
- 40°C ambient radiator
- Heat exchanger cooling (project specific)
- External electric pumps for engine cooling circuits complete with thermostats (project specific)

Heat Recovery

- Water jacket heat exchangers
- Exhaust gas heat exchangers
- Exhaust gas boilers
- Separate lubricating oil cooling circuit

Exhaust System

- Industrial type silencer
- Residential type silencer
- Length of flexible exhaust and bellows

Generator Set

- Weather protecting ISO style containers
- Silenced ISO style containers, 85 dB(A) at 1 metre

Miscellaneous

- Flexible water, oil and air connections
- Duplex (running change) lubricating oil filters
- Crankcase breather filter

Control Panel

- 3 or 4 pole circuit breaker (separate enclosures)
- CE Compliance
- Remote monitoring capabilities
- System control (master) panel

Dimensions and Weights

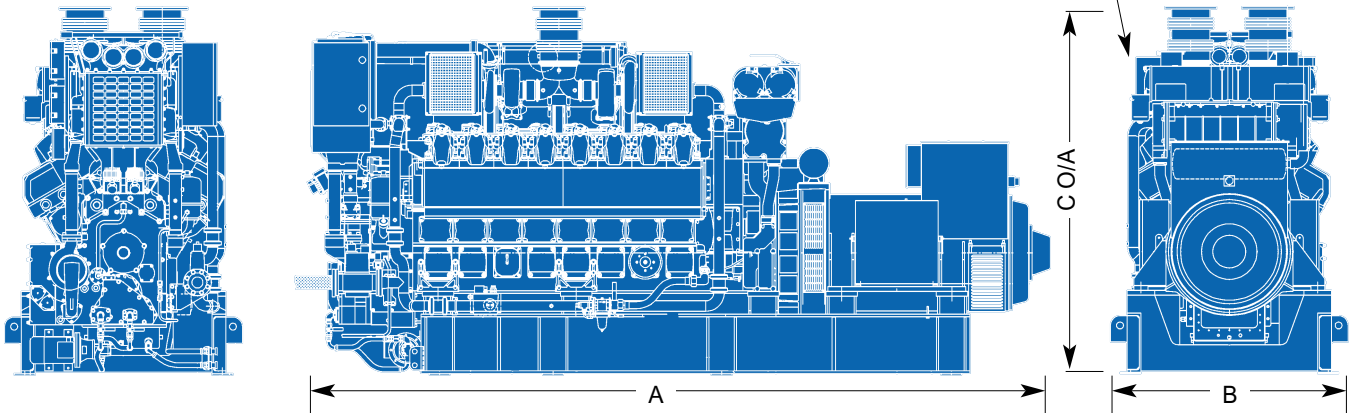

	Dimensions and Weights (mm)			Set Weight kg Dry	Set Weight kg Wet
	A	B	C		
Without bed mounted radiator	5356	1721	2661	14832	16137

Dimensions and weights are for **guidance** only. Do not use for installation design. Ask for certified drawings on your specific application. Specifications may change without notice.



Power Generation

See your distributor for more information.

Cummins Power Generation Limited
 Manston Park, Columbus Avenue
 Manston, Ramsgate
 Kent CT12 5BF, UK
 Telephone: +44 (0)1843 255000
 Fax: +44 (0)1843 255902
 Email: cpg.uk@cummins.com
www.cumminspower.com
www.cummins.com

Cummins is a registered trademark of Cummins Inc.